

COMMERCIAL DATA SHEET

Quadra Plus 5 XR & Gooseneck

Billi®

Billi Quadra Plus 5 with XR Remote Dispenser & Gooseneck Mixer

Enjoy all the space saving benefits of Billi's water cooled boiling and chilled Quadra systems PLUS a separate sink mixer to ensure safety and convenience for all users.

Requiring only cold feed mains supply, the Quadra Plus mixes it's own hot water without the need for any additional under-bench space requirements or boosters.

All Quadra Plus boiling & chilled models are Global GreenTag certified to a Gold standard and require no joinery ventilation. Supplied standard with the innovative and thoughtful XR remote control panel drinking water dispenser, (useful for ambulant or wheelchair inclusive access), and 6 star rated round gooseneck mixer tap, the solution is both functional and appealing.



BOILING



CHILLED



PLUS



XR Remote Dispenser

Gooseneck Mixer

Quadra Plus Under-Bench Unit



Features



SPACE SAVING DESIGN



SAFE TO OPERATE



ENERGY EFFICIENT



HEAT EXCHANGE TECHNOLOGY



WATER COOLED TECHNOLOGY



NO CUPBOARD VENTILATION REQUIRED



AUSTRALIAN DESIGNED & MADE





GREENTAG CERTIFIED



EASY INSTALLATION

PRODUCT SPECIFICATIONS

Water type	Product code	Model name	Dispenser	Suggested no. of people	50° hot water capacity litres (initial drawdown)	50° hot water delivery litres per hour	Boiling water delivery (cups per hour)*	Chilled water delivery (cups per hour)	Power supply (amps)
  BOILING CHILLED	904025RG	Quadra Plus 5	XR Remote	Up to 25	7	40	120	175	10
 PLUS									

* Based on the initial number of cups of boiling water immediately available, drawn one cup every 10 seconds. For all underbench filtered water systems, consideration may be needed for usage patterns and draw-off methods. 1 cup = 170ml

Accessories

992800 - 70mm Riser & Font

992820 - 70mm Riser

992803 - 120mm Riser & Font

992830 - 120mm Riser



990714 - Tubing Extension Kit for Plus unit - 1.8mtrs

Finishes

Standard Finish

CH - Chrome

Add the Finish code to the Product Code to finalise your specification, eg. 904025RGCH

TECHNICAL DRAWINGS

PRODUCT DIMENSIONS

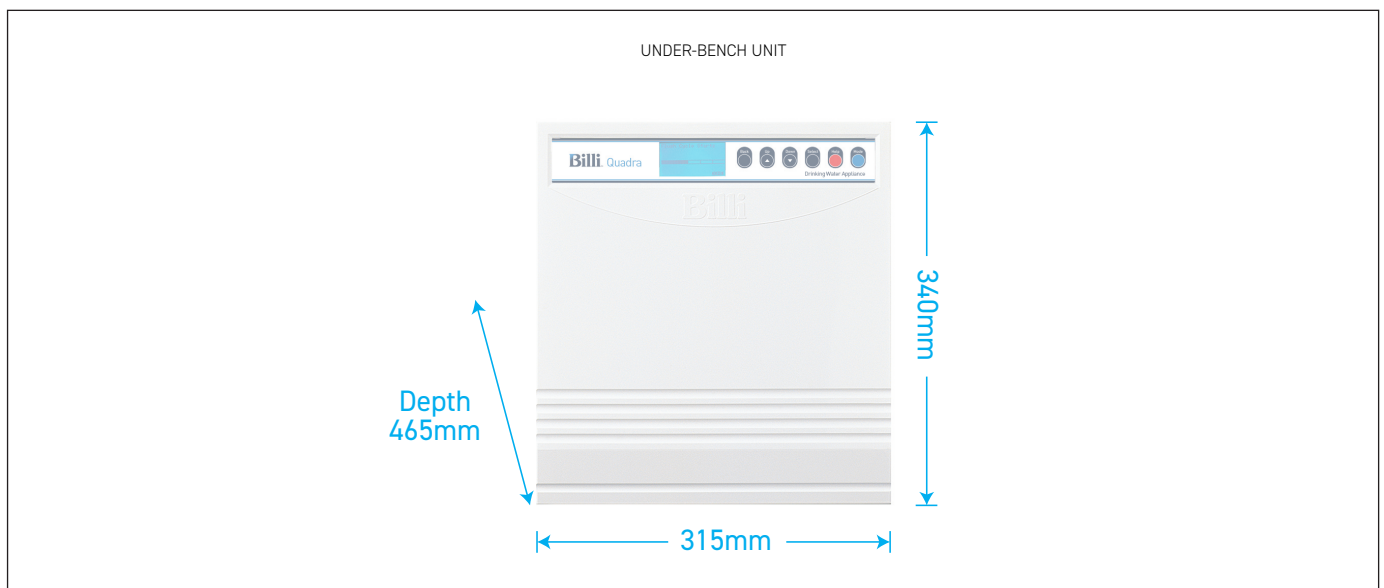
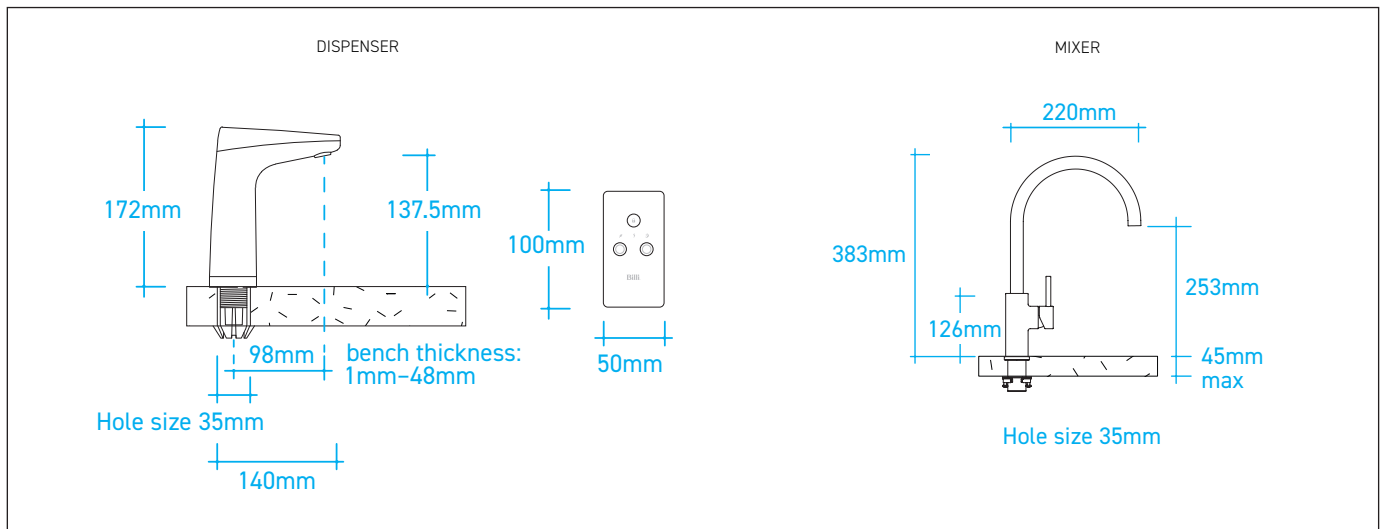

INSTALLATION REQUIREMENTS

PREFERRED INSTALLATION LAYOUT

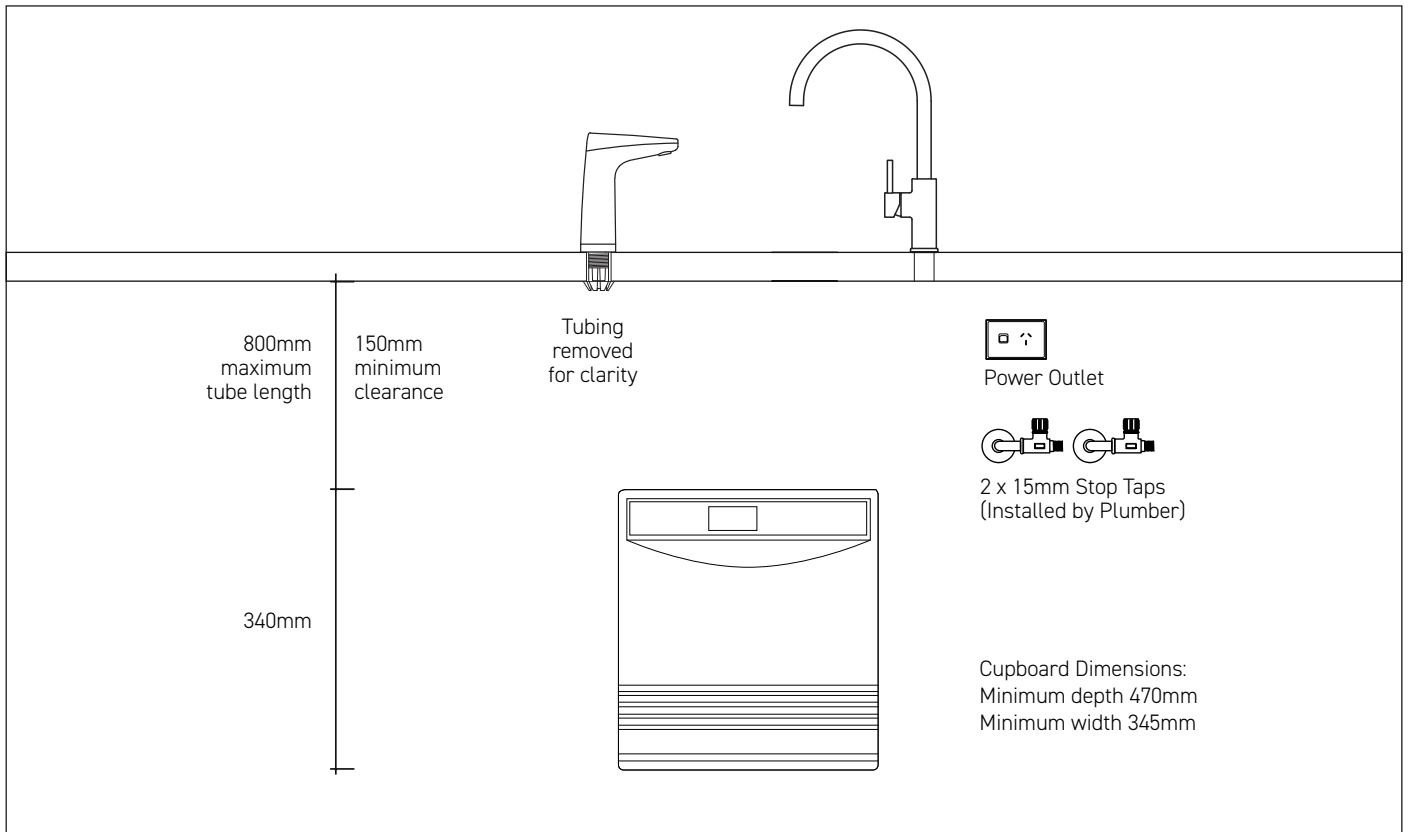

WATER SUPPLY

Two (2) 1/2" BSP (15mm) stop-taps with a male thread should be installed in an easily accessible position. Water supply must be microbiologically safe to drink, with a minimum dynamic water pressure of 250kPa and a maximum of 1000kPa.

POWER SUPPLY

A standard 10 amp power outlet is required, located no further than 1000mm from the underbench unit. The system is supplied with a 1 metre flex cord and plug.

FILTRATION

Billi's range of premium filters utilise BWT's unique Fibron X technology. Billi's filter range provides superior taste, water quality, consistent filter life and peace of mind when it comes to hygiene.

Filter supplied: 994051 (5 micron). Replacement filters available: 994052 (0.2 micron), 994054 (HSD), 994055 (XPHSD), 994056 (Sediment only) and 994060 (0.2 micron sediment only).

CERTIFICATIONS

Every Billi drinking water appliance is manufactured under a certified quality control system. All Billi commercial range models have been tested and comply with all required standards including: Watermark: WM-021525; Certified to AS/NZ3498 and AS/NZ 4020; ISO9001:2015, QEC 11627; Section J6.6 of the BCA; Global GreenTag LCARate Gold; HACCP: PE-872-WAT-1-02; WELL Cornerstone Member; WELS 6 star rating registration T40039.

WARRANTY

The Billi Quadra Plus Range is covered by a comprehensive 2 year warranty on all parts and labour.

Billi®



Billi Australia Pty Ltd
42 Lucknow Crescent,
Thomastown, Victoria
3074 Australia

P 1800 812 321
F +61 3 9469 0499
W www.billi.com.au

visit us at



Designed and manufactured in Australia to the highest quality standards